

CamGrind L

Superproductive and perfect for batch production

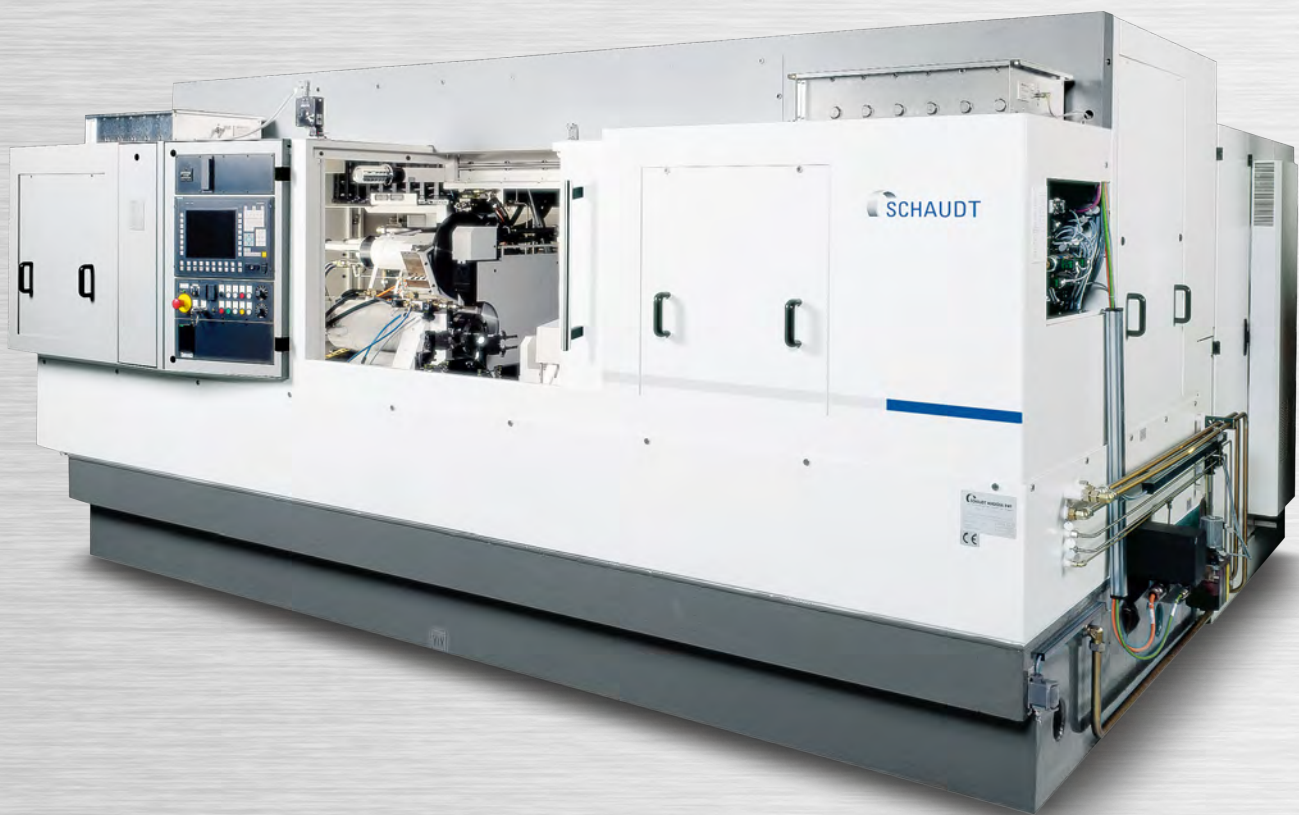

Key data

The CamGrind L as a single-slide or two-slide machine allows you to machine shaft-type components with a length of up to 2,000 mm or 650 mm. This superproductive grinding machine offers brand new design options for cylindrical and noncircular grinding in mid to high volume production. You will find the perfect solution for any complex grinding task.

Schautd Mikrosa GmbH

Schautd Mikrosa GmbH is synonymous worldwide for premium technology in cylindrical, noncircular, and universal grinding between centers, as well as in centerless external cylindrical grinding. Since 2009, the company combines the two long-established brands SCHAUDT and MIKROSA in a modern factory in Leipzig.

Our special strength lies in the high customer-individuality of our machines and the connection of units, automation components and process engineering to a highly productive grinding system.

Here, SCHAUDT is the brand for the automotive industry and its suppliers. It offers sophisticated technological solutions for cylindrical, noncircular and eccentric grinding. Our highly experienced experts also have unparalleled expertise in the high-precision grinding of long and heavy workpieces like rollers and turbine shafts. Within this broad application range, you obtain everything from a single source – application development, technology, assembly, and sales.

MIKROSA sets the standards in centerless external cylindrical grinding of rotationally symmetrical parts. The modular machine design means that you obtain a solution with handling and automation individually tailored to your grinding task. The technology spectrum extends from precision infeed grinding in many different variations to super productive throughfeed grinding. This allows you to machine a very large variety of workpieces, from small jet needles through to large shafts.

Schautd Mikrosa GmbH is part of the UNITED GRINDING group, one of the leading suppliers of machines, applications, and services for hard-fine machining worldwide. The group comprises eight strong brands with own subsidiaries and sales partners around the world to be a strong partner for our customers.

CamGrind L

Maximum productivity for high volume production · Patented swivel-in spindle technology · Robot automation · Superproductive multiwheel technology · Complete machining · Simultaneous machining · User-friendly WOP-G programming system

Features

Dimension

- Grinding length of single-slide machine 650/1,100/2,000 mm
- Grinding length of two-slide machine 650 mm
- Height of centers 220 mm
- Max. grinding wheel dimension 480 x 80 mm, further variants depending on configuration
- Max. workpiece weight 50 kg

Hardware

- Granitan® machine base / machine base of welded steel construction filled with mineral casting
- Cross slide machine
- Single-slide or two-slide variant with up to 4 grinding wheels
- Patented swivel-in spindle
- B-axis
- Multiwheel technology
- Optional: automation with robot



Software

- Service-friendly SIEMENS SINUMERIK 840D sl control system
- Proven WOP-G programming software for grinding cylindrical and noncircular workpiece contours with user-oriented set-up interface
- Standardized interfaces for loader and peripheral devices

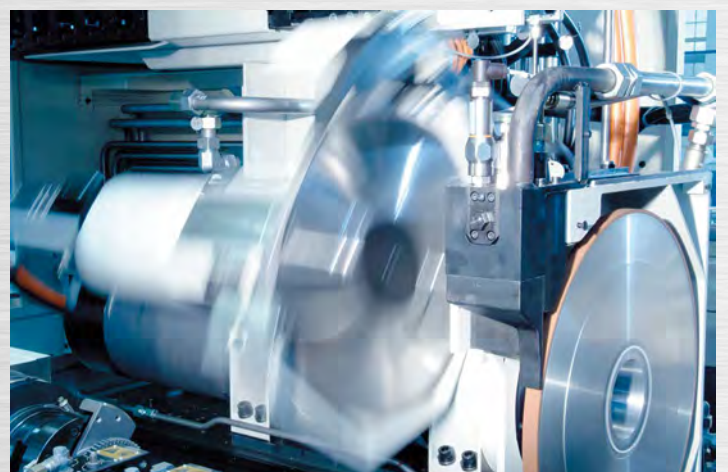
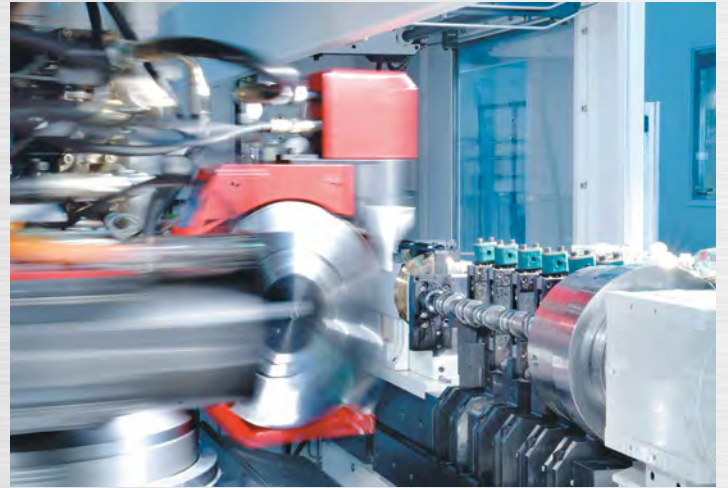

CamGrind L as single-slide variant



Your advantages

- Compact cross slide machine
- Single-slide machine with max. 3 grinding wheels
- Arrangement of machine table at 20° angle for optimal rigidity
- Digital drives for high-precision axis positioning
- Swivel-in spindle technology
- B-axis

The CamGrind L is designed as a single-slide machine for shaft-type workpieces up to 2,000 mm in length, depending on overall size. It can be provided with a second swivel-in spindle or B-axis, so that in addition to individual machining complete production lines are also possible.

Featuring swivel-in spindle technology, the single-slide variant is suitable for grinding concave profiles with the highest precision and short intervention times. The B-axis variant is particularly flexible. It has room for up to three grinding spindles and enables further interesting grinding processes. Any angle can be swiveled to within the swiveling range of 240°. With a swivel angle of 120°, a chip-to-chip time of under 8 seconds is possible. The available spindle variants make the CamGrind L single-slide machine very flexible. The machine can be retooled or upgraded easily if the application requirements change, saving on investment.

The guide is mounted on roller bearings with hydraulic clamping. This design principle is particularly distinguished by its low overall height of just 100 mm. This results in a high static and dynamic rigidity for individual machining and production lines. The absolute angle measuring system integrated into the direct drive offers maximum angular and repeatability precision.

CamGrind L as two-slide variant



The two-slide variant of the CamGrind L provides a cost-effective solution for the complete machining of complex shaft-type workpieces in a single clamping. The machine offers brand new design options for cylindrical and noncircular grinding, thanks to expedient reduction of the process chain. Processing times are decisively shortened, transport and idle times are avoided and space requirement is considerably reduced. Even complex machining processes can be performed without any problem. A unique feature is simultaneous machining with two wheels with a minimum grinding wheel distance of 20 mm. As closely juxtaposed surfaces can be simultaneously ground, the machining time is significantly reduced. Complete machining in a single clamping has clear advantages in many cases. Particularly as regards changing machining tasks in mid to high volume production, both cycle times and investment costs can be reduced, with consistently high quality. Complete machining is very demanding, as many different machining tasks in relation to diameters, shoulders, cones, radii, keyways and noncircular contours must be solved simultaneously with different grinding processes. This is no problem for the CamGrind L two-slide variant: It offers maximum design options for the grinding processes. For example, plunge grinding, shoulder grinding or grinding with wheel sets can be executed in parallel on the various grinding spindles. For especially high-performance applications a modern KUKA robot can be integrated into the CamGrind L2.

Your advantages

- Compact cross slide machine
- Two-slide machine with max. 4 grinding wheels
- Arrangement of machine table at 20° angle for optimal rigidity
- Digital drives for high-precision axis positioning
- Swivel-in spindle technology with two grinding wheels even at closely juxtaposed grinding points (min. 20 mm)
- Multiwheel technology
- Optional: Automation with robot

Machine base

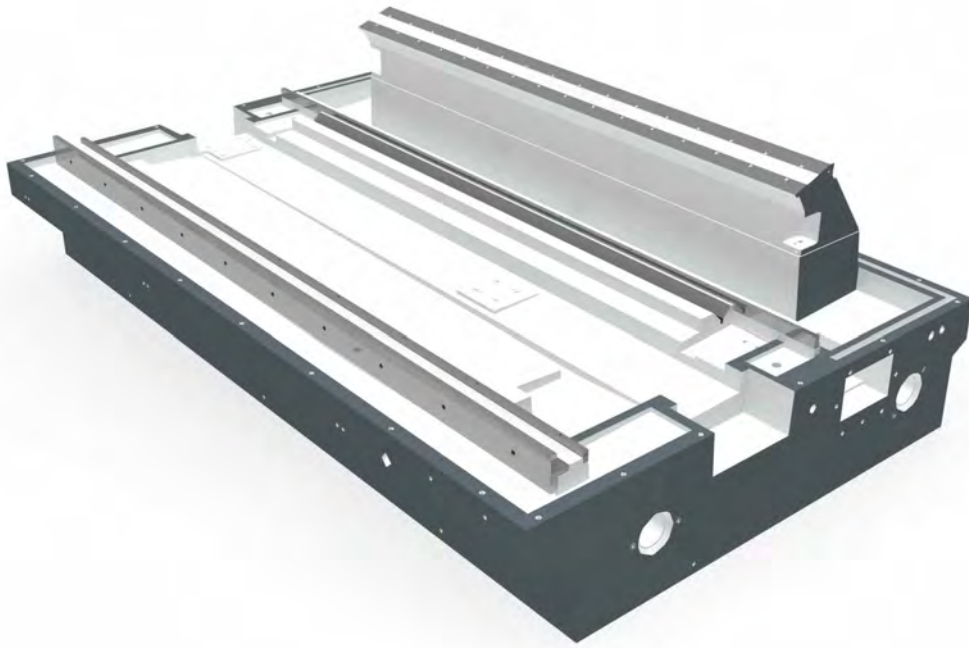

Your advantages

- Vibration-damping
- Thermally stable
- High dimensional stability

The CamGrind L single-slide variant has a proven Granitan® machine bed. This material possesses excellent damping characteristics and high thermal stability. This is a big advantage when machining workpieces with high quality requirements. Temporary temperature fluctuations are extensively compensated and a high tolerance holding capacity can be guaranteed throughout the day. The guide system for the machine's flexible cross slide is formed directly in the machine bed. The guideways offer the highest possible accuracy through the entire speed range with high load capacity and cushioning levels.

The machine bed of the two-slide machine comprises a welded steel construction, which is partially filled with mineral aggregate. As a result it possesses good damping characteristics and favorable thermal behavior, similar to Granitan®. The machine bed is particularly suitable for large machines, as it weighs less than a purely mineral cast bed. An additional special foundation is not required for either machine variant.

Swivel-in spindle

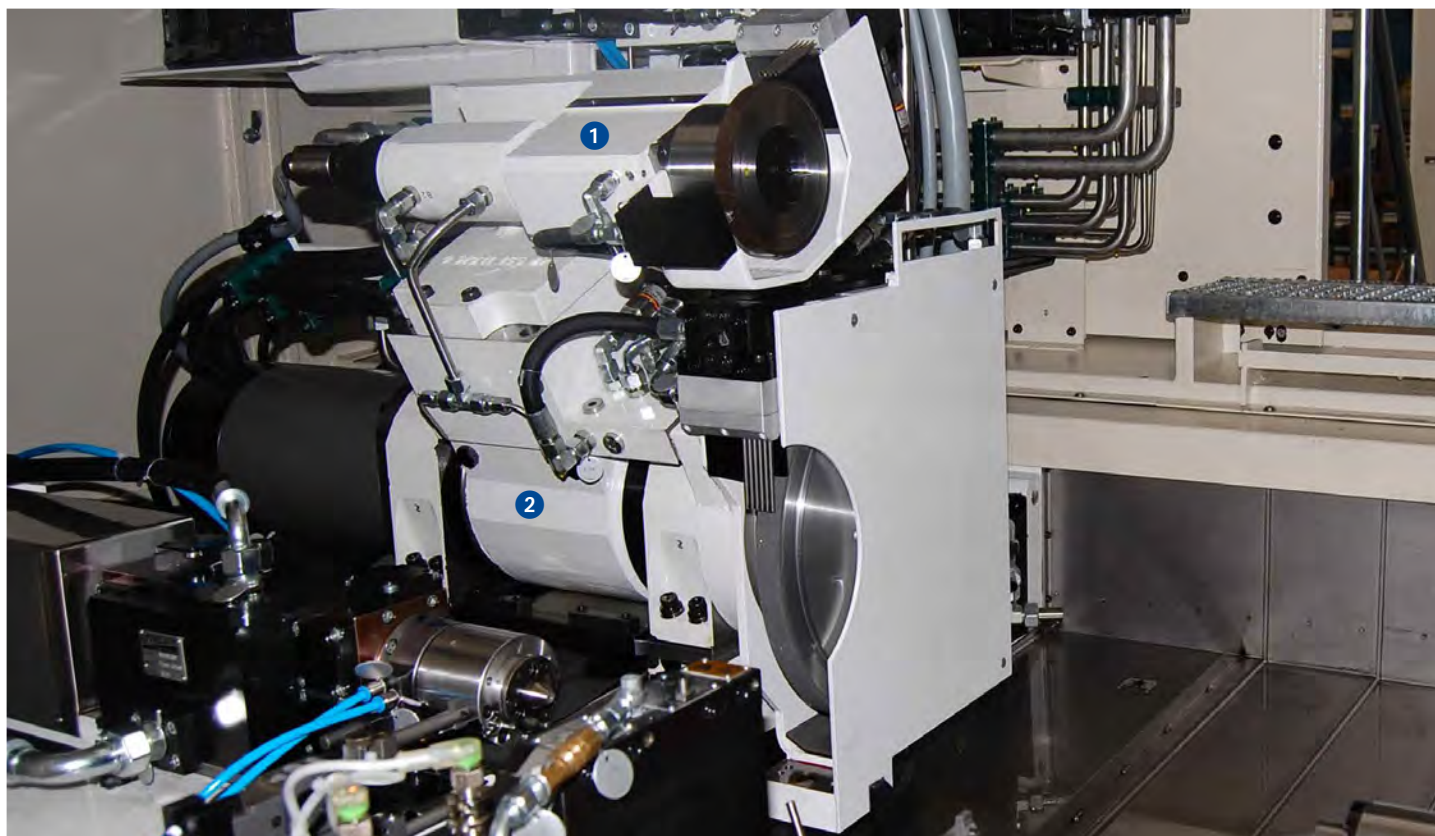

Your advantages

- Great machining flexibility
- Max. spindle power 30 kW
- Machining of the smallest concave radii

SCHAUDT's patented swivel-in spindle allows the CamGrind L to be equipped with up to four grinding wheels. This significantly increases the machine's productivity and flexibility. The spindle is mainly equipped with ceramic CBN wheels. Electroplated or metal-bonded tools can also be used.

The spindle power varies from 6 to 30 kW, depending on the grinding task. A wide variety of concave contours can thus be machined with the swivel-in spindle. The high metal removal rate of the main spindle is utilized simultaneously. The chip-to-chip time is 3 seconds when changing from main to swivel-in spindle. Balancing occurs fully or semi-automatically, depending on the spindle type.

Workhead

1

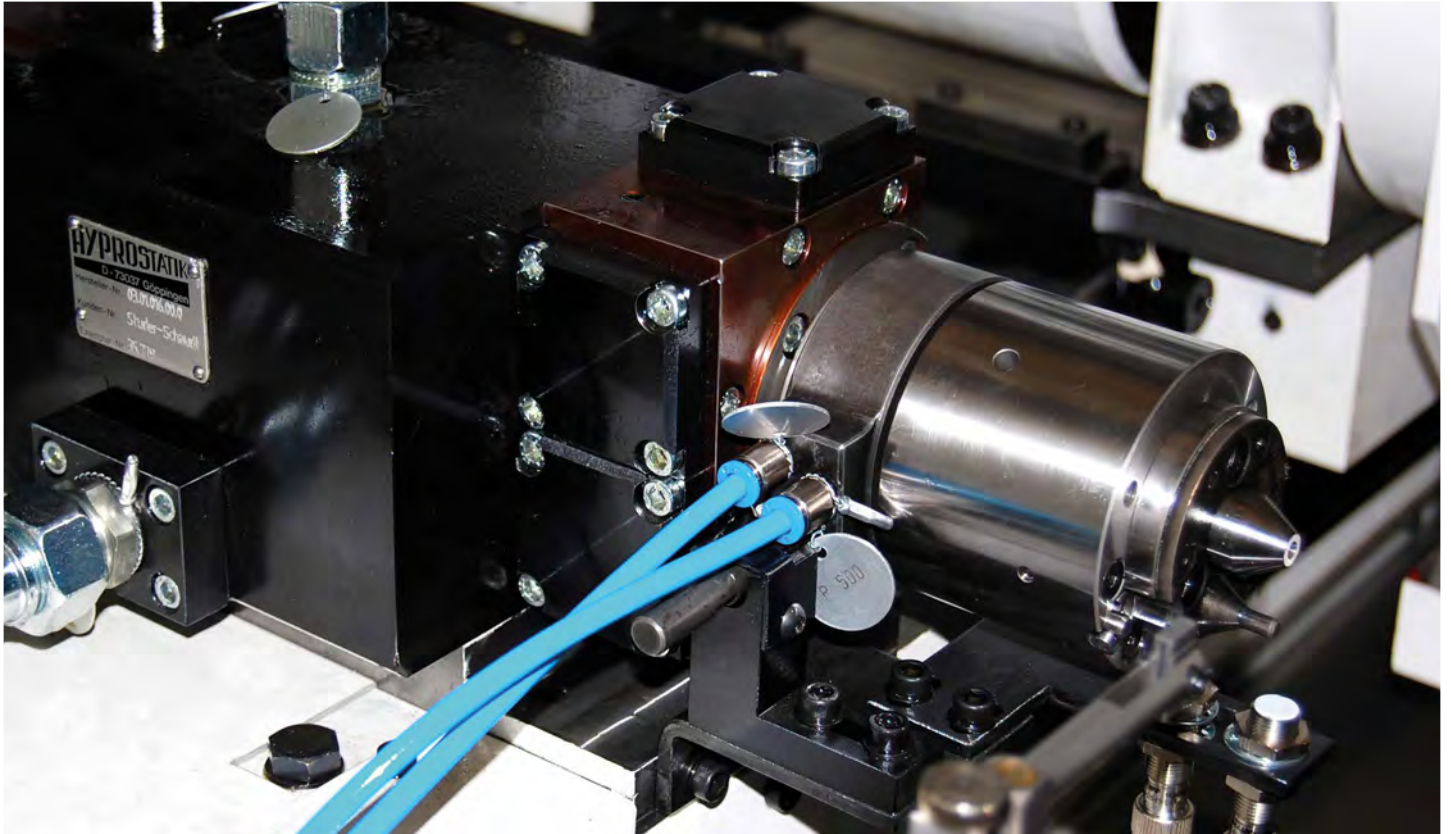

2



Your advantages

- Excellent runout characteristics
- High rigidity
- Good torque curve
- High dynamics

The CamGrind L features a high-precision, directly powered workhead, which has excellent runout characteristics. In C-axis mode the headstock is distinguished by an outstanding torque curve and extremely high dynamics, so that highly complex noncircular forms can also be machined without problem.

The rigid design of the directly powered spindle makes the headstock suitable for clamping with MK4 center points as well as for chuck operation. An additional workhead is available for the two-slide machine. Because of its hydrostatic bearing, its block size is reduced to a minimum. This enables the use of a swivel-in spindle with a grinding wheel diameter of min. 120 mm on the left grinding unit. Concave contours can also be simultaneously ground.

Tailstock

1

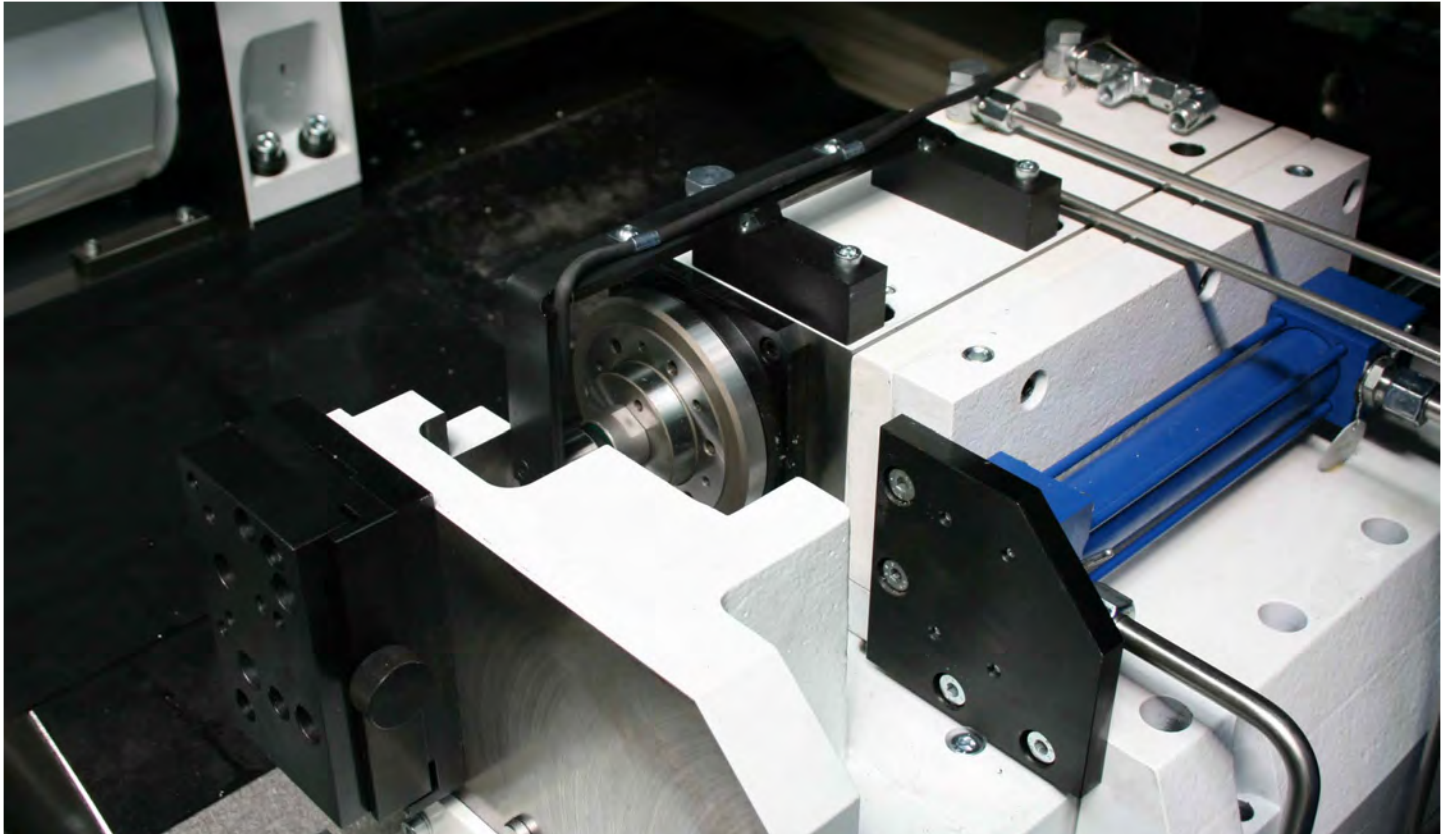

2

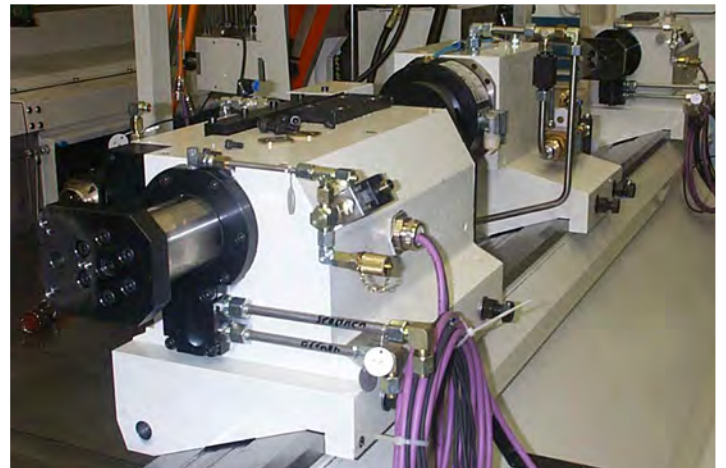

Your advantages

- Great versatility
- Pressure changeover (option)
- Positioning capability (option)

The hydraulically actuated slide tailstock of the CamGrind L has a stroke of 150 mm. The tailstock can therefore be used for several workpieces without any set-up time. Monitoring of several clamping positions is also possible. The clamping pressure can be continuously adjusted manually. It is also possible to switch between two values. Optional positioning via a length measuring system further increases flexibility. The slide tailstock has a mounting surface for mounting a rotating dressing tool. An additional tailstock is available for the single-slide machine. Its barrel guide makes it especially suitable for heavy workpieces.

B-axis

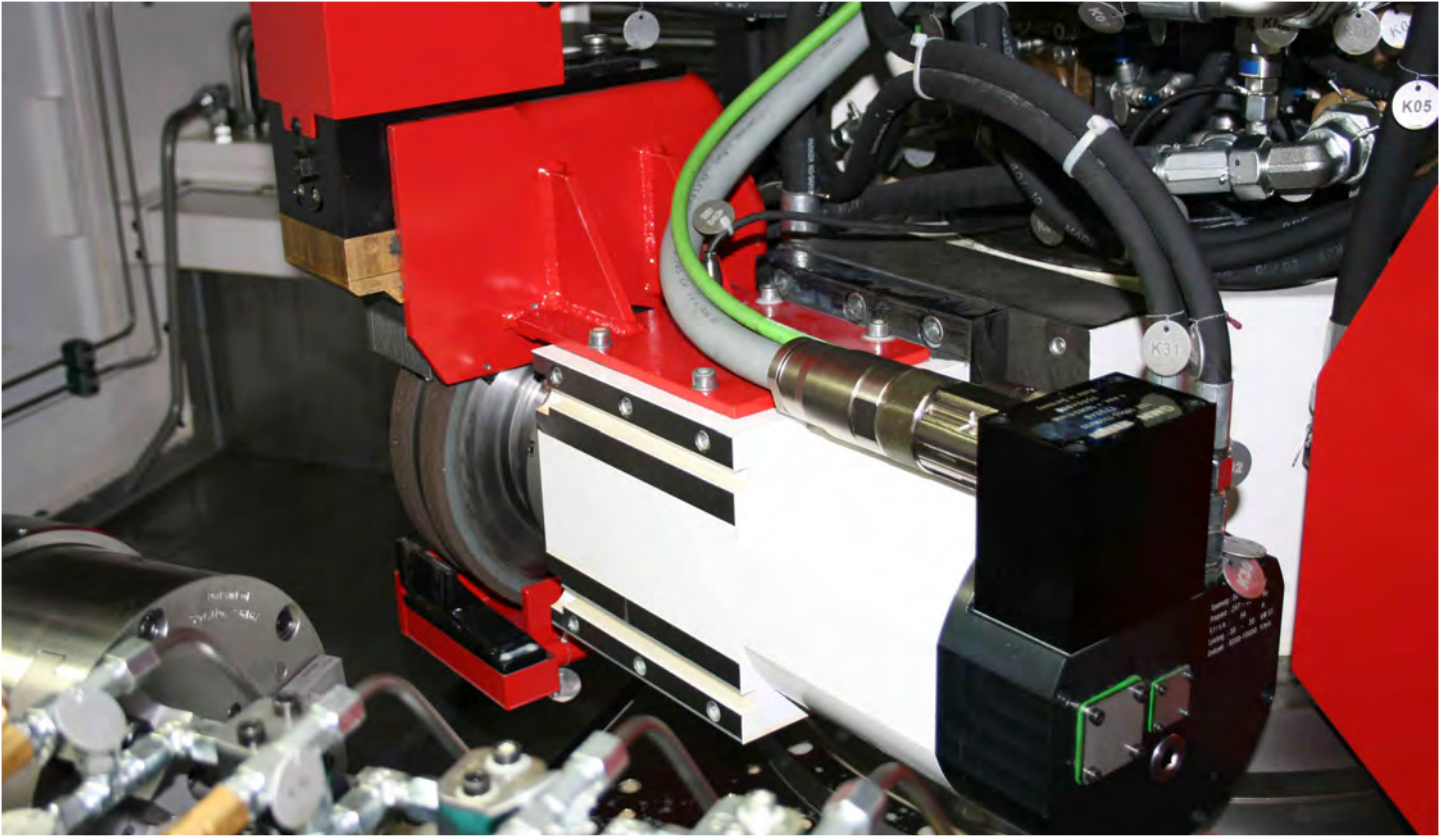

Your advantages

- Flexible
- Use of up to 4 grinding spindles
- Surface grinding using angular plunging
- Taper grinding without a profile disc

The B-axis with its three grinding spindles offers the optimal solution for every machining task. Any angle can be swiveled to within the swiveling range of 240°. A torque motor is used as direct drive. With a swivel angle of 120°, this enables a chip-to-chip time of less than 8 seconds. The guide is designed as a roller bearing with hydraulic clamping. This design principle is particularly distinguished by its low overall height of just 100 mm. This results in a very high static and dynamic rigidity.

The absolute angular position measuring system integrated into the direct drive offers maximum angular and repeatability precision. Grinding wheels in the diameter range of 70 to 340 mm can be used, depending on the machining task. The B-axis enables further interesting grinding processes, such as grinding flat shoulders using the angular plunge method or taper grinding using the plunge method without profiled grinding wheel.

Multiwheel technology

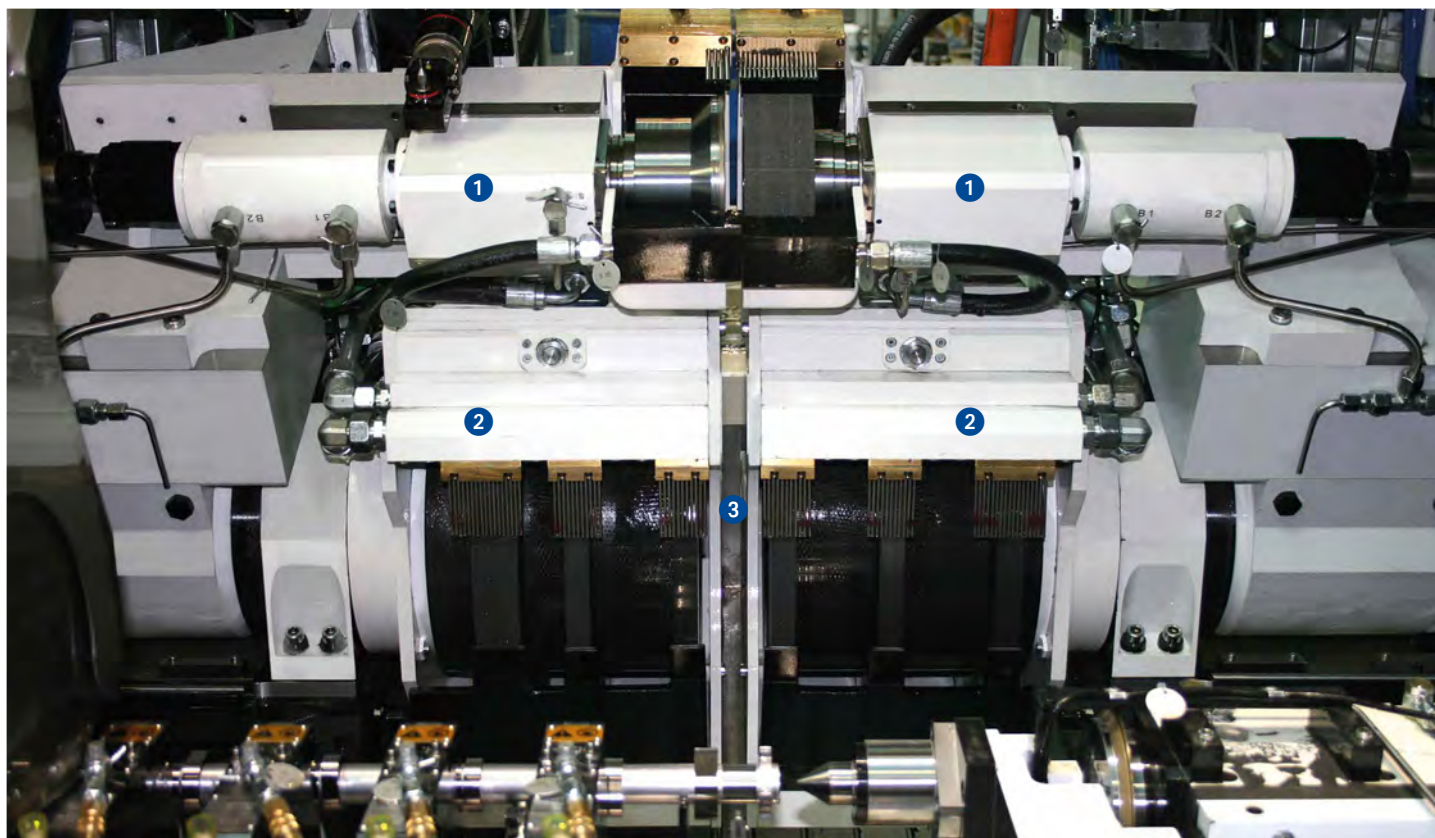

Your advantages

- Quick cycle times
- High accuracies during bearing grinding
- Process flexibility

The further development of simultaneous machining into multiwheel technology means that all cylindrical features of a workpiece can be ground in a single plunge. This reduces the cycle time to a minimum and the productivity of the machine increases accordingly. At the same time the precision of the bearings in relation to each other also increases significantly. Even widely differing bearing widths on a workpiece do not present a problem for multiwheel technology. This is a clear advantage in comparison to methods with single or double wheels.

The productivity achieved in the grinding process can be compared to centerless grinding, while at the same time the reference to the centerings is preserved. Thanks to the optionally available swivel-in spindles the noncircular contours of the workpiece can also be machined highly efficiently in the same clamping.

In-process gauging

1



Your advantages

- Higher accuracies
- Lower reject rate
- Automatic operation possible without manual corrections

High-precision in-process measuring heads can be used in the CamGrind L without problem. Measurement occurs during the grinding process and eliminates the need for manual corrections by the machine operator. As a result auxiliary times are shortened significantly, and cycle times are reduced accordingly.

A measuring head can be used to measure the bearings of a shaft, for example. The diameter range depends on the workpiece to be ground and is between 5 and 120 mm. The in-process measuring head delivers high precision even under production conditions and guarantees excellent thermal stability over long periods of time.

Measurement is also possible if only noncircular profiles are machined on the machine. The measurement occurs post-process in parallel with machining the next noncircular profile.

Swivel-in measuring probe



Your advantages

- Flexible
- No set-up required
- User-friendly

The CamGrind L is optionally equipped with a swivel-in measuring probe. This is mounted on the cross slide, which results in tremendous flexibility without additional set-up. The swivel-in process occurs pneumatically or hydraulically, depending on the version. The measuring probe can be used to determine both the longitudinal position and the angular position of a workpiece. Measurement of lengths is also possible.

Highly productive machining solutions

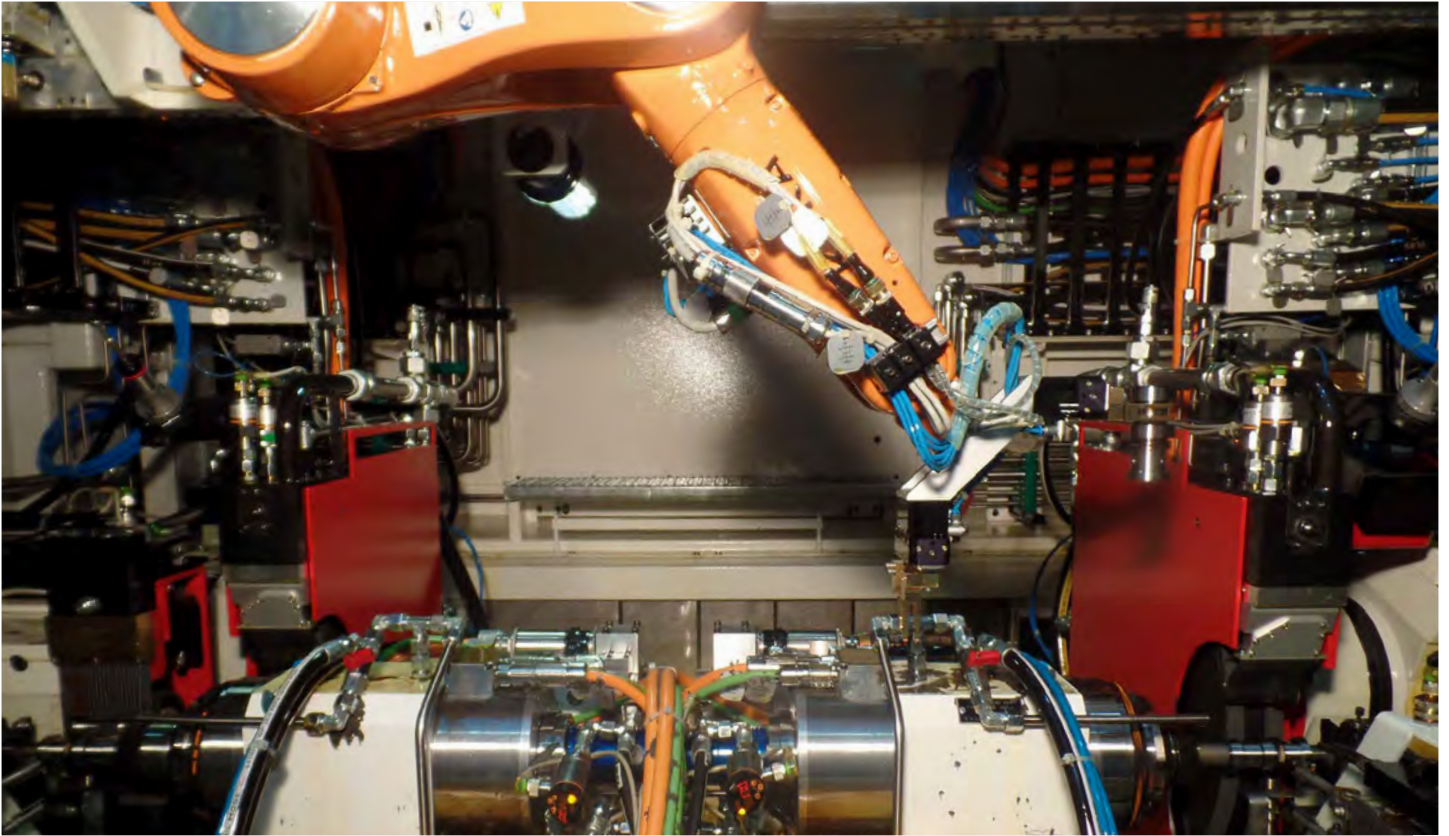

Your advantages

- Very short cycle times
- Two workheads for highly productive output
- Integrated KUKA loading robot
- Integrated interface for machine control

For especially high-performance applications such as the grinding of cam units, the two-slide variant of the CamGrind L can be equipped with two grinding stations. These are supplied with workpieces in staggered cycles by a compact KUKA robot, which is protected against oil and water in accordance with IP 67.

Particularly advantageous is the fact that the robot can be directly controlled with the Sinumerik 840D sl via the Run MyRobot software interface. Machine and robot can be simply integrated into the machine process via a central control unit with a convenient operator interface.

The machine operator can program and configure the integrated robot entirely from the operating panel of the CamGrind L2. The axis movements are represented in the X, Y and Z directions typical for machine tools. The operator is guided accurately through the input mask on the basis of the programming interface developed by Schaudt Mikrosa.

WOP-G programming interface

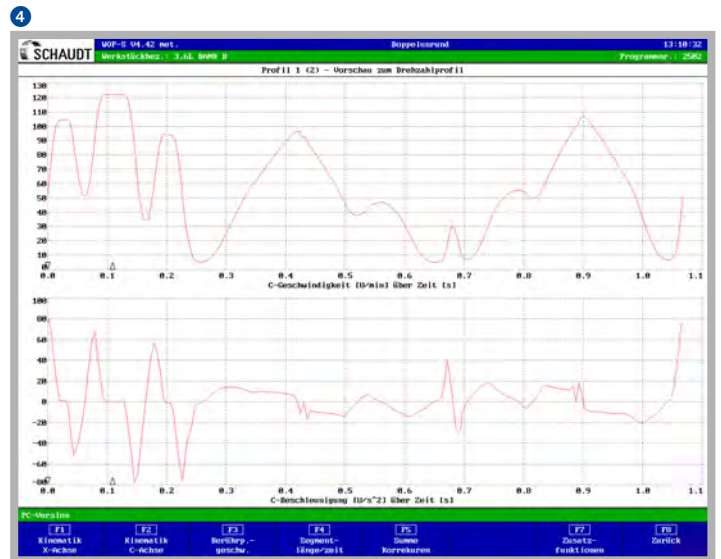
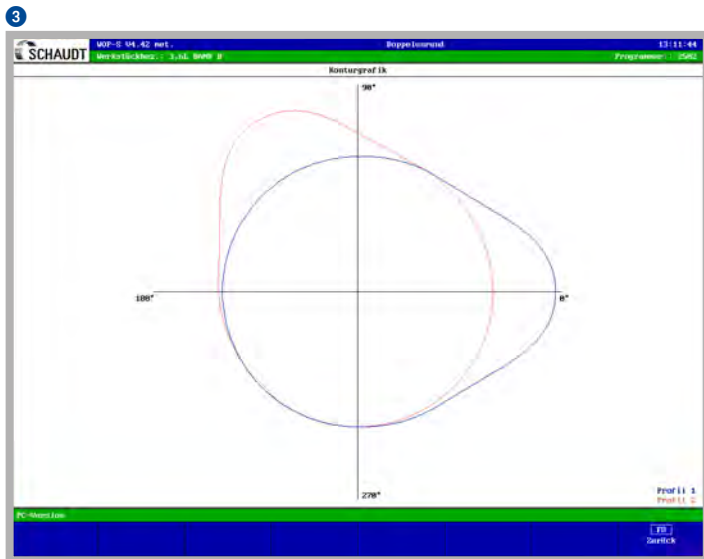
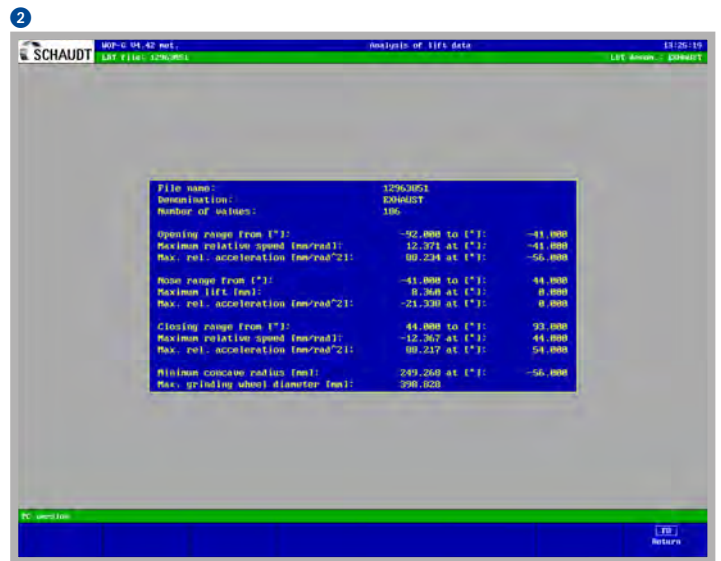
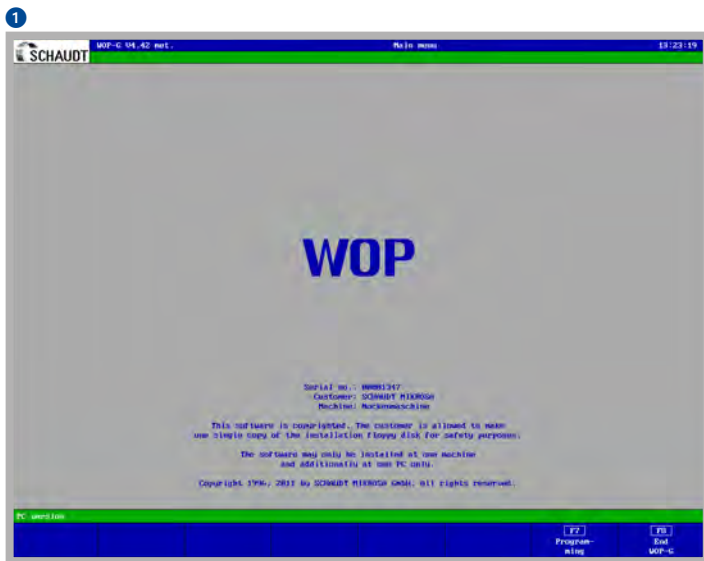

Your advantages

- User-friendly
- Easy creation of grinding programs
- Wide functional scope

The WOP-G programming system from SCHAUDT enables quick and easy programming of cylindrical and noncircular workpiece contours. From just a few inputs WOP-G creates harmonic speed profiles, which can be variably adapted. This enables combination machining of concave and convex profiles in a single clamping with the highest precision. The contour data are read in via a data table. No special formatting is required. The input profiles are stored in a database and can be called up again at any time. A shape analysis of the contour can be performed in respect of concavity and relevant maximum values, based on the read-in table.

The WOP-G programming software can also be used on another external computer, creating an additional external programming station. If the machine also has network access, a common data pool can be accessed via both the control system and the external programming station.

Customer Care

SCHAUDT grinding machines should fulfill the customer's requirements for as long as possible, work cost-effectively, function reliably and be available at all times. From "start up" through to "retrofit" – our Customer Care is there for you throughout the working life of your machine. 12 professional helplines and more than 60 service technicians are available in your area, wherever you are in the world.

- We will provide you with fast, uncomplicated support.
- We will help to increase your productivity.
- We work professionally, reliably and transparently.
- We will provide a professional solution to your problems.



Start up
Commissioning
Warranty extension



Qualification
Training
Production support



Prevention
Maintenance
Inspection



Service
Customer service
Customer consultation
HelpLine
Remote service

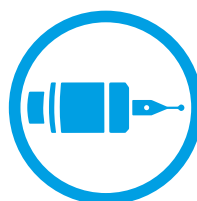

Material
Spare parts
Replacement parts
Accessories



Rebuild
Machine overhaul
Assembly overhaul



Retrofit
Modifications
Retrofits

Technical data

CamGrind L1 – Single-slide

Working range

Grinding length between centers, max.	mm	650/1,100/2,000
Height of centers	mm	220
Workpiece weight between centers, max.	kg	130

Wheelhead

X-axis guide		hydrostatic
Z-axis guide		hydrostatic
Swivel-in spindle: grinding wheel diameter*	mm	70-370
B-axis		yes
Main spindle: grinding wheel diameter, max.*	mm	340-480
Main spindle: grinding wheel width, max.*	mm	80
Grinding wheel drive power, max.	kW	40
Grinding wheel peripheral speed, max.	m/s	125

Workhead

Number of revolutions, max.	rpm	1,000/50
Torque	Nm	50/25

Tailstock

Stroke, max.	mm	60/75/100/150
--------------	----	---------------

SINUMERIK 840D sl control system

yes

Dimensions

Machine weight	t	12-14
Height, max.	mm	2,253
Footprint	mm	4,158-4,758 x 3,632-4,554

Variants

U01, U03, U12

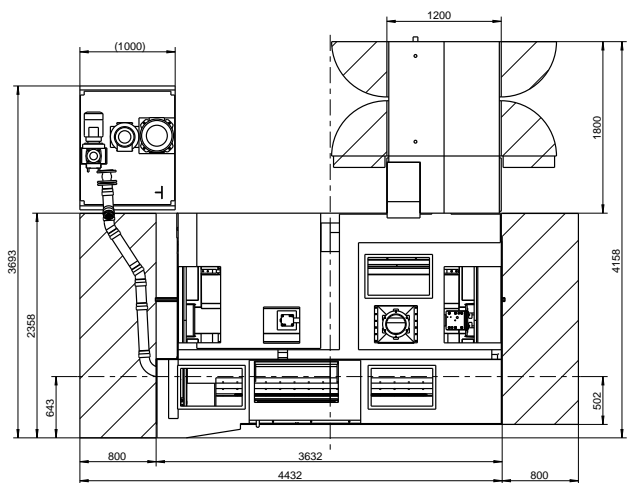
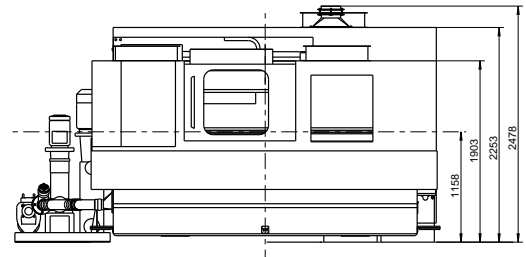
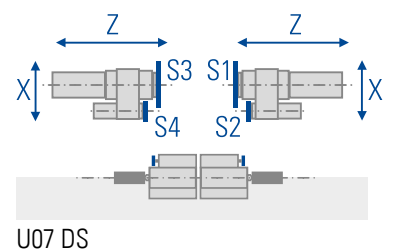
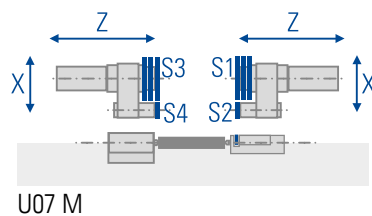
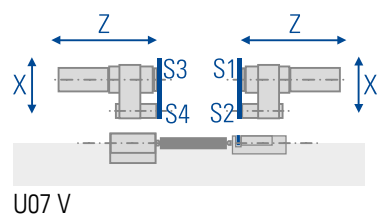
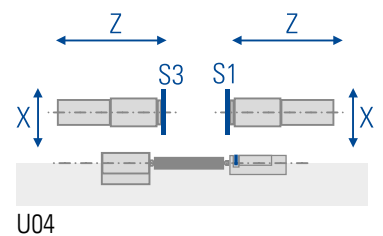
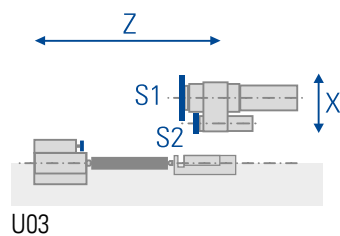
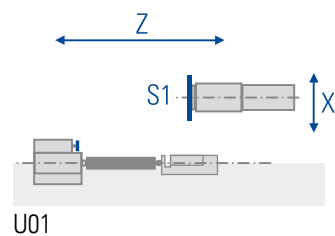

Layout CamGrind L1, 650 mm distance between centers

* Standard, further variants depending on configuration

CamGrind L2 – Two-slide

Working range

Grinding length between centers, max.	mm	650
Height of centers	mm	220
Workpiece weight between centers, max.	kg	50

Wheelhead

X-axis guide		hydrostatic
Z-axis guide		hydrostatic
Swivel-in spindle: grinding wheel diameter*	mm	70-370
B-axis		no
Main spindle: grinding wheel diameter, max.*	mm	400-480
Main spindle: grinding wheel width, max.*	mm	250
Grinding wheel drive power, max.	kW	40
Grinding wheel peripheral speed, max.	m/s	125

Workhead

Number of revolutions, max.	rpm	1,000/500
Torque	Nm	50/25

Tailstock

Stroke, max.	mm	60/75/100/150
--------------	----	---------------

SINUMERIK 840D sl control system

yes

Dimensions

Machine weight	t	18/20
Height, max.	mm	2,253/2,791
Footprint	mm	4,758 x 4,554

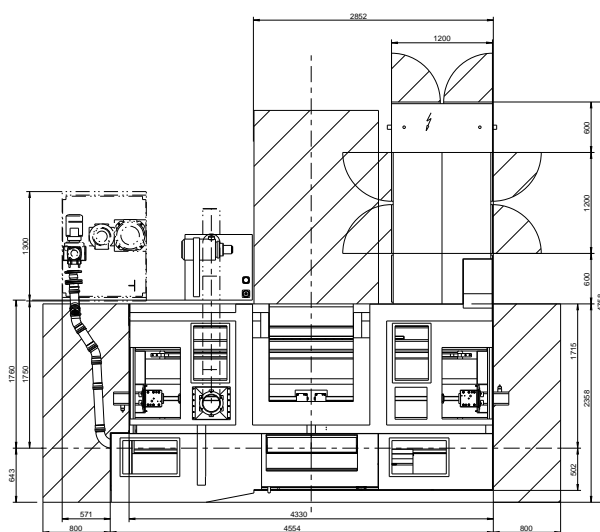
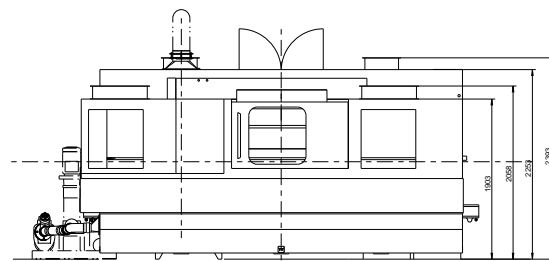

Layout CamGrind L2

Layout CamGrind L1, 1,100 mm distance between centers

Variants

U04, U05, U06, U07

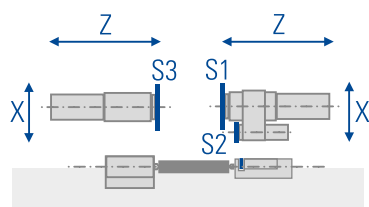

U05

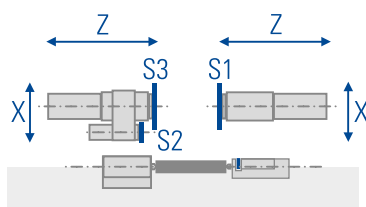

U06

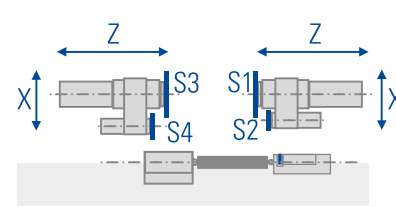

U07 N

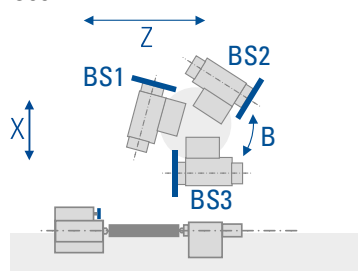

U12

* Standard, further variants depending on configuration



Schaudt Mikrosa GmbH
Saarländer Straße 25
04179 Leipzig
Germany
Tel. +49 341 4971 0
Fax +49 341 4971 500
sales@schaudtmikrosa.com
www.schaudt.com

